

Standard function type inductive sensors **LR30X** series

Features

- ◆ Non contact detection, safe and reliable;
- ◆ ASIC design;
- ◆ Perfect choice for metallic targets detection;



Part number

NPN NO	LR30XBF10DNO	LR30XBN15DNO	PNP NO	LR30XBF10DPO	LR30XBN15DPO
NPN NC	LR30XBF10DNC	LR30XBN15DNC	PNP NC	LR30XBF10DPC	LR30XBN15DPC
NPN NO+NC	LR30XBF10DNR	LR30XBN15DNR	PNP NO+NC	LR30XBF10DPR	LR30XBN15DPR

Technical specifications

Mounting	Flush	Non-flush	Current consumption	≤15mA	
Rated distance [Sn]	10mm	15mm	Circuit protection	Short-circuit, overload and reverse polarity	
Assured distance [Sa]	0...8mm 0...12mm		Output indicator	Yellow LED	
Dimensions	M30*52mm	M30*64 mm	Ambient temperature	-25°C...70°C	
Output	NO/NC (depends on part number)		Ambient humidity	35-95%RH	
Supply voltage	10...30 VDC		Switching frequency [F]	500 Hz	300 Hz
Standard target	Fe 30*30*1t	Fe 45*45*1t	Voltage withstand	1000V/AC 50/60Hz 60s	
Switch-point drifts [%/Sr]	±10%		Insulation resistance	≥50MΩ(500VDC)	
Hysteresis range [%/Sr]	1...20%		Vibration resistance	10...50Hz (1.5mm)	
Repeat accuracy [R]	≤3%		Degree of protection	IP67	
Load current	≤200mA		Housing material	Nickel-copper alloy	
Residual voltage	≤2.5V		Connection type	2m PVC cable	

Dimensions

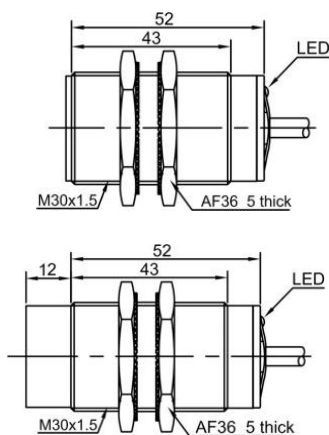

Wiring diagram

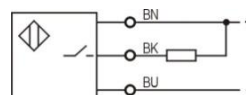

NPN NO

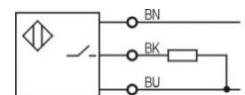

PNP NO

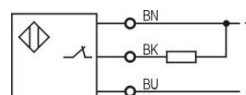

NPN NC

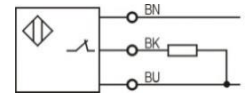

PNP NC

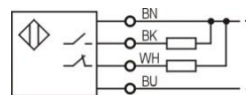

NPN NO+NC

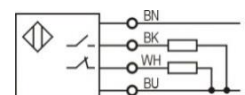

PNP NO+NC