

Metal cylindrical shape inductive sensors **LR18X** series

## Features

- ◆ Extended sensing distance;
- ◆ ASIC design, safe and reliable;
- ◆ Perfect choice for metallic target detection;



## Part number

NPN NO	LR18XBF08DNOY-E2	LR18XBN12DNOY-E2	PNP NO	LR18XBF08DPOY-E2	LR18XBN12DPOY-E2
NPN NC	LR18XBF08DNCY-E2	LR18XBN12DNCY-E2	PNP NC	LR18XBF08DPCY-E2	LR18XBN12DPCY-E2
NPN NO+NC	LR18XBF08DNRY-E2	LR18XBN12DNRY-E2	PNP NO+NC	LR18XBF08DPRY-E2	LR18XBN12DPRY-E2

## Technical specifications

Mounting	Quasi -flush	Non-flush	Current consumption	≤15mA	
Rated distance [Sn]	8mm	12mm	Circuit protection	Short-circuit, overload and reverse polarity	
Assured distance [Sa]	0...6.4mm	0...9.6mm	Output indicator	Yellow LED	
Dimensions	M18*63mm	M18*75mm	Ambient temperature	-25°C...70°C	
Output	NO/NC(depends on part number)		Ambient humidity	35-95%RH	
Supply voltage	10...30 VDC		Switching frequency [F]	400 Hz	200 Hz
Standard target	Fe 24*24*1t/Fe 36*36*1t		Voltage withstand	1000V/AC 50/60Hz 60S	
Switch-point drifts[%/Sr]	≤±10%		Insulation resistance	≥50MΩ (500VDC)	
Hysteresis range [%/Sr]	1...20%		Vibration resistance	10...50Hz (1.5mm)	
Repeat accuracy [R]	≤3%		Degree of protection	IP67	
Load current	≤200mA		Housing material	Nickel-copper alloy	
Residual voltage	≤2.5V		Connection type	M12 connector	

## Dimensions

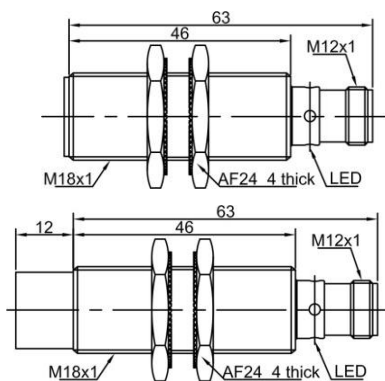

## Wiring diagram

